

## Offline, Non-Isolated, 23V, 45mA Auxiliary Power Supply

### General Description

The HV9922DB2 is a universal input, offline, non-isolated auxiliary power supply using Supertex's HV9922 constant current switching regulator IC. The output voltage is regulated to 23V +/-5% and is referenced to the negative side of the diode bridge rectifier (i.e. ground of the rectified DC voltage). The demoboard is protected against output open circuit and short circuit conditions and meets FCC Class B (residential) EMI limits.

The HV9922 acts as a constant 50mA current source which is sourced into an output zener diode. On the demoboard, a 22V zener diode is used at D2 to regulate the output voltage to 23V within +/-5%. Lower output voltages can be obtained by using an appropriate 2W zener diode in parallel to D2 in the space provided on the demoboard (D3).

### Specifications

Parameter	Value
Input voltage:	85 - 265VAC, 50/60Hz
Output voltage:	23V +/-5%
Output current:	0 - 45mA
Switching frequency:	variable
Full load efficiency:	50% (at 110V input), 44% (at 220V input)
Open circuit voltage:	24V
Output short circuit protection:	Included
Dimensions:	53.4mm x 38.2mm

### Board Layout and Connection Diagram



### Connections:

**Input:** Connect the input AC voltage between AC1 and AC2 as shown.

**Output:** Connect the output load between VO+ and VO- as shown. An ammeter and voltmeter can be connected as shown to measure the output voltage and load current if desired.

**WARNING:** Do not use earth grounded test instruments or loads! Doing so will short the AC line, resulting in damage to the instrument, load and/or the HV9922DB2. Use an isolated supply or high voltage differential probes when testing the circuit.

*There is no galvanic isolation. Dangerous voltages are present when connected to the AC line.*

## Demoboard Testing:

**Normal Operation:** Power up the input voltage. Measure the output voltage and load current. The output voltage will be regulated to 23V +/- 5%.

Note that, when left in this condition, the output voltage will slowly drift. This drift is due to the power dissipation in the zener diode, which causes the zener voltage to drift. This drift will eventually settle down once the temperature of the zener diode stabilizes. This drift is not destructive and the output voltage will not increase more than 5%.

To obtain an output voltage less than 22V, space is provided on the HV9922DB2 for a zener diode (D3) in parallel with the existing 22V zener diode. By soldering in an appropriate 2W zener diode, the HV9922DB2 can be customized to produce the required output voltage.

**Line Regulation:** Decrease the load resistance until the load current reads the full load value of 45mA. Then, vary the input voltage between 85VAC and 265VAC and note the output voltage. The output voltage of the HV9922DB2 will remain in regulation over the entire line range.

**Load Regulation:** Set the input voltage at a desired value. Vary the output load so that the load current is in between 0 and 45mA. The output voltage will remain in regulation over the entire load range.

**Short Circuit Test:** With the HV9922DB2 operating in a steady state, connect a jumper across the load (please note that since there is no galvanic isolation on the demoboard, this test should be done with care). Notice that the output current rises to about 50mA and remains there.

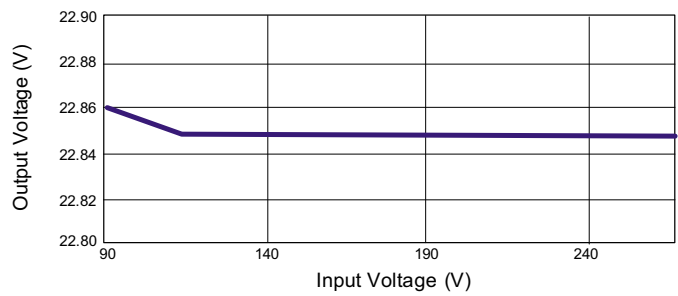
The HV9922DB2 is protected against a short circuit by resistor R1 (200 ohm resistor). When the output of the demoboard is shorted, the 50mA current develops a 10V drop across R1 to prevent loss of regulation. This voltage is sufficient to ensure that the inductor L1 does not go into saturation and thereby protects the circuit. However, this resistor dissipates about 0.5W of power during normal operation, causing a drop in the overall efficiency of the circuit. If short circuit protection is not required, R1 can be eliminated. The difference in efficiencies with and without R1 is shown in the Typical Results section.

Please note that at least 10V of total output voltage (drop across the D2/D3 combination + drop across R1) is required to ensure proper operation of the HV9922DB2. A lower voltage will not be sufficient to reset the inductor L1, and might cause the inductor to go into saturation. Thus, if R1 is eliminated, the minimum zener diode that can be used in D3 is a 10V zener diode. If lower output voltages like 5V are desired, R1 cannot be removed.

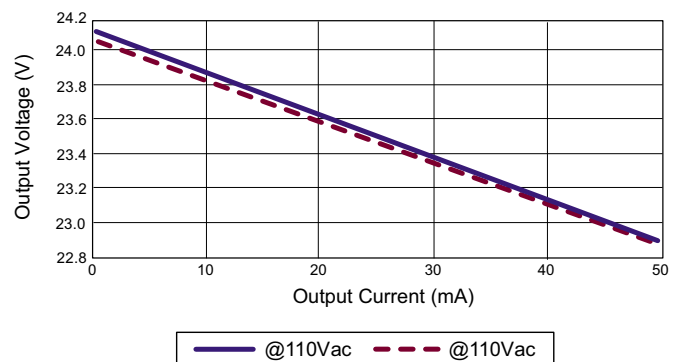
## Typical Results

**Output Voltage Regulation:** The regulation of the output voltage of the HV9922DB2 at various input voltages is shown in Fig.1 (measured at full load of 45mA). Fig.2 shows the load regulation of the output voltage at 110VAC and 220VAC.

**Fig.1 Line Regulation of Output Voltage**

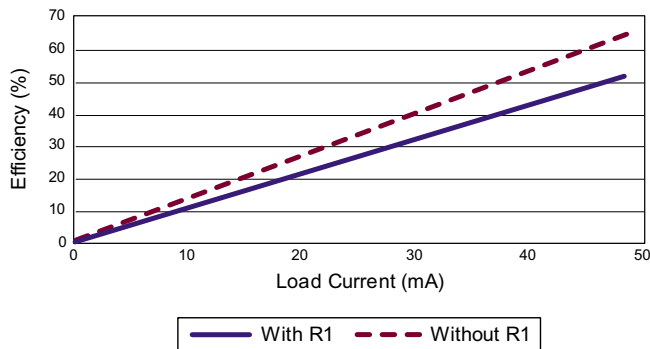


**Fig.2 Load Regulation of Output Voltage**

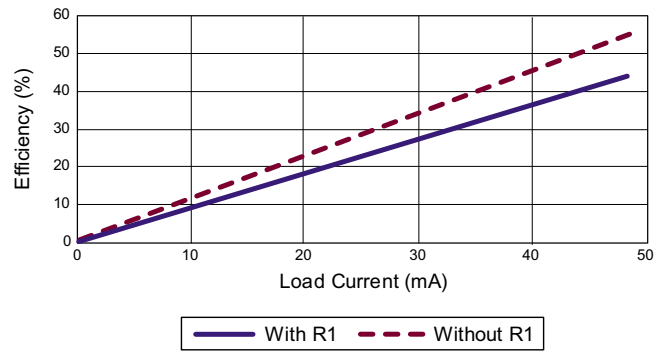


**Efficiency:** Figs.3 and 4 show the efficiency of the HV9922DB2 at 110V input and 220V input respectively. The efficiency of the converter without the short circuit protection resistor is also plotted to show the effect of the resistor on efficiency. With the resistor removed, the full load efficiency increases by about 15% at 110V input and by about 11% at 220V input.

**Fig.3 Efficiency of HV9922DB2 at 110VAC Input**



**Fig.4 Efficiency of HV9922DB2 at 220VAC Input**



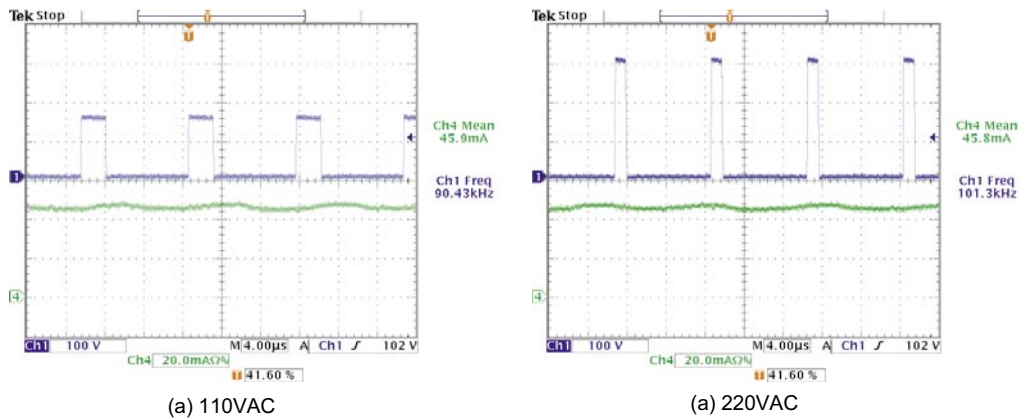
**Normal Operation:** Fig.5 shows the source voltage (GND pin) of the HV9922 and the output current during normal operation (full load) at 110VAC and 220VAC.

**Input Current Waveshape:** Fig.7 shows input voltage and input current waveforms at 110VAC and 220VAC.

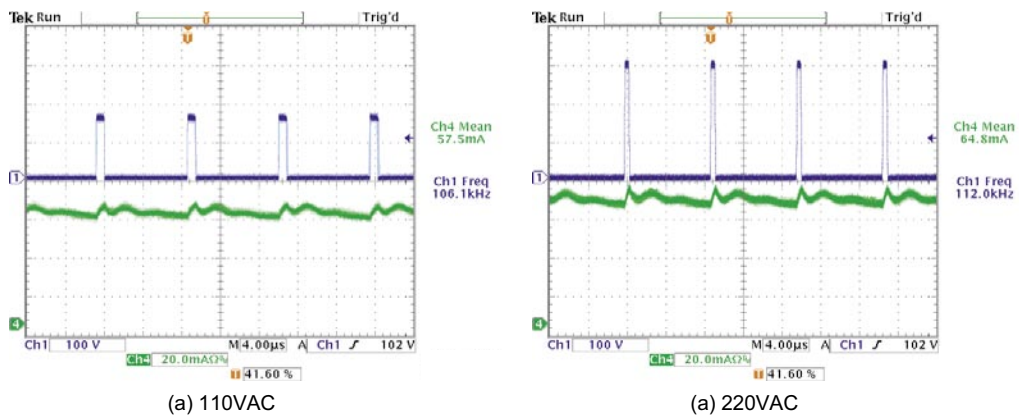
**Output Short Circuit Protection:** Fig.6 shows the source voltage of the HV9922 and the output current waveforms for output short circuit condition at both 110VAC and 220VAC inputs.

**Conducted EMI Measurements:** The plot of the conducted EMI measurements over the frequency range of 150kHz to 30MHz is shown in Fig.8. The limits line corresponding to FCC Class B is also plotted.

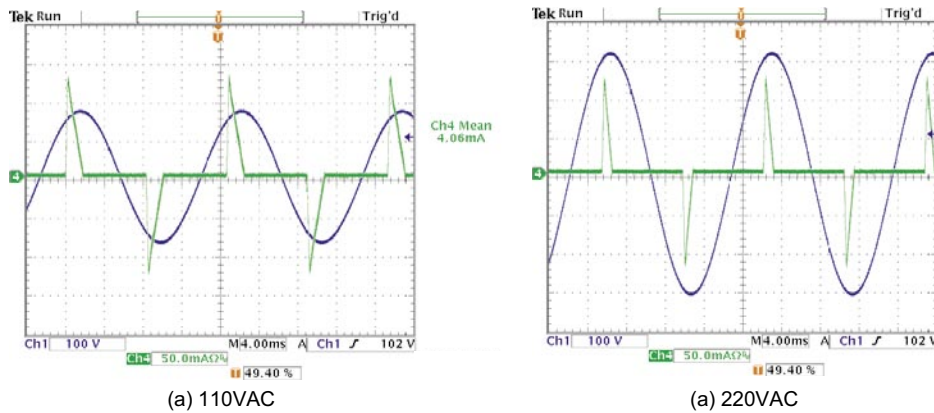
**Fig.5 Voltage Current and Waveforms During Normal Operation**



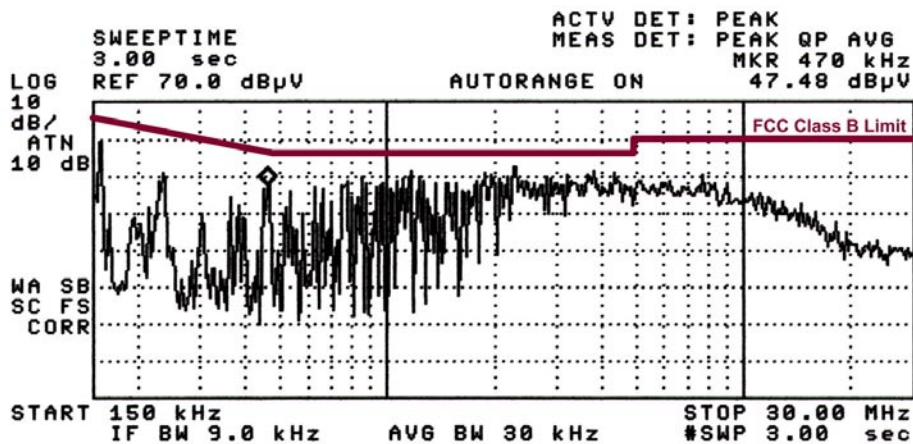
**Fig.6 Voltage Current and Waveforms During Output Short Circuit**



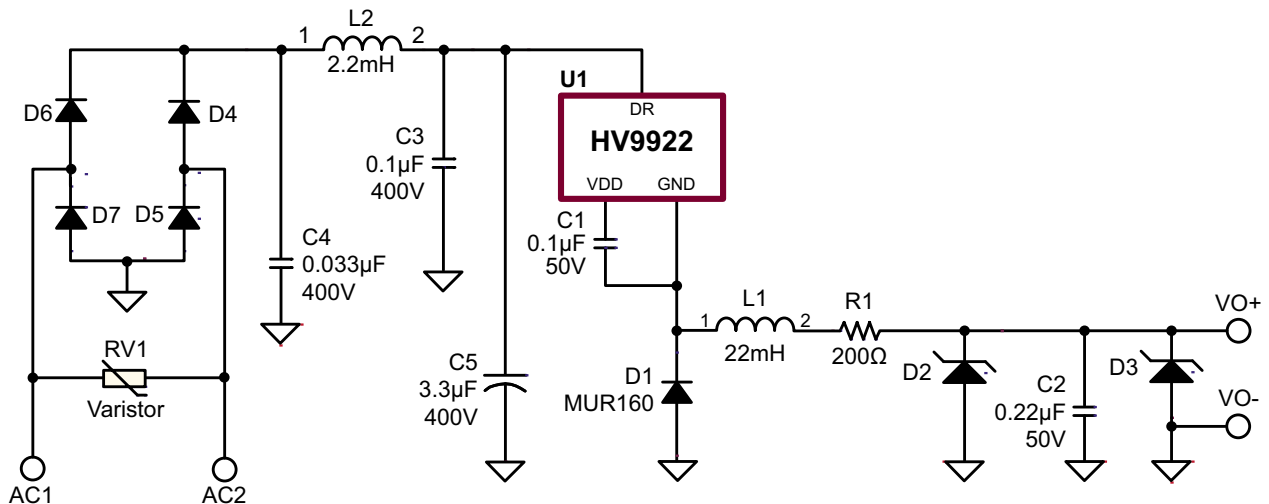
**Fig.7 Input Voltage and Input Current Waveforms**



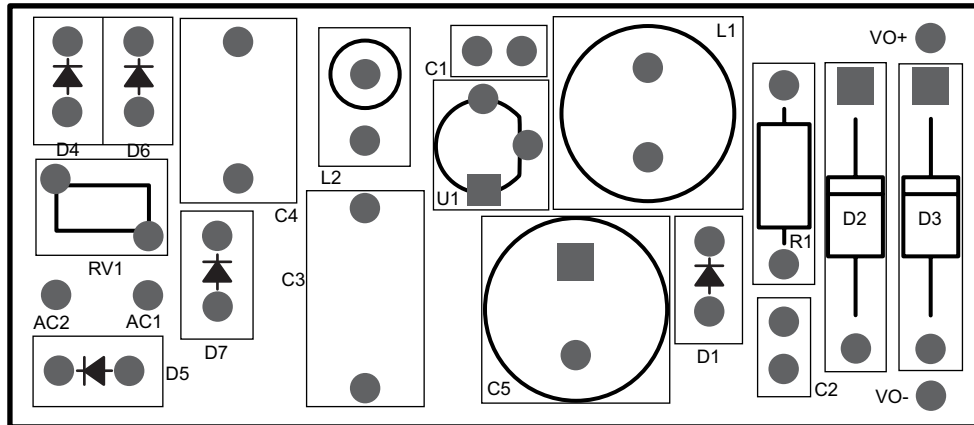
**Fig.8 Conducted EMI Plot for HV9922DB2**



**Circuit Schematic:**



Silk Screen



Bill of Materials

Item #	Qty.	Ref.	Description	Package	Manufacturer	Part Number
1	1	C1	0.1µF, 50V, X7R, MLCC	Thru-hole	Epcos	B37987F5104K054
2	1	C2	0.22µF, 50V X7R ceramic capacitor	Thru-hole	TDK Corp	FK20X7R2E224K
3	1	C3	0.1µF, 400V, metalized polyester film	Thru-hole	Panasonic	ECQ-E4104KF
4	1	C4	0.033µF, 400V, metalized polyester film	Thru-hole	Panasonic	ECQ-E4333KF
5	1	C5	3.3µF, 400V electrolytic capacitor	Radial	Nichion	UVR2G3R3MPD
6	1	D1	600V, 1A ultrafast diode	DO-41	On Semiconductor	MUR160
7	1	D2	22V, 5W zener diode	Thru-hole	Microsemi	1N5358B
8	1	D3	open	-	-	-
9	4	D4, D5, D6, D7	600V, 1.0A standard recovery diode	DO-41	Diodes, Inc	1N4005
10	1	L1	22mH, 60mA, Mini-Drum	Thru-hole	Renco Electronics	RL-5480-3-22000
11	1	L2	2.2mH, 64mA, Axial	Thru-Hole	Central Technologies	CTH6-222K
12	1	RV1	Surge absorber	Thru-Hole	Panasonic	ERZ-V05D431
13	1	R1	200Ω, 1W resistor	Thru-hole	Phoenix Passive Components	2306 328 33201
14	1	U1	LED Driver	3-Lead TO-92	Supertex	HV9922N3-G

**Supertex inc.** does not recommend the use of its products in life support applications, and will not knowingly sell them for use in such applications unless it receives an adequate "product liability indemnification insurance agreement." **Supertex inc.** does not assume responsibility for use of devices described, and limits its liability to the replacement of the devices determined defective due to workmanship. No responsibility is assumed for possible omissions and inaccuracies. Circuitry and specifications are subject to change without notice. For the latest product specifications refer to the **Supertex inc.** (website: <http://www.supertex.com>)